

Knockdown (KD) Frame Installation Instructions

for Steel or Wood Stud and Drywall construction

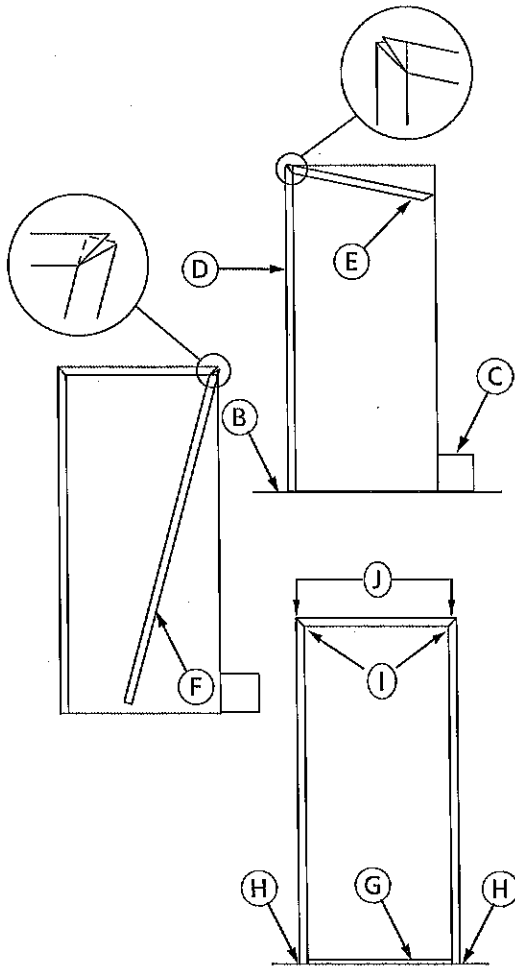

- Construct wall with rough opening height equal to finished frame opening height plus 3/4" (19.1) to 1" (25.4). Maximum rough opening width for a 2" face frame is opening width plus 2-1/8" to 2-3/8".
- Bottom of frame must set on a solid surface.
- If wrap-around base anchor is used, notch drywall in that area.
- Retract compression bars near the top of the jambs by turning screws counter clockwise and install one jamb in position on wall.
- Insert frame head under the corner clips of the jamb and raise into position.
- Insert the corner clips of the remaining jamb into the opposite end of the head and position jamb on wall.
- Locate a removable frame spacing bar at base of centered frame to maintain proper opening width during installation.
- Level, square, and plumb frame and install base anchor screws through countersink holes in frame face and into floor plate.
- Square top of frame and tighten compression bars by turning screws clockwise.
NOTE: DO NOT OVER TIGHTEN.
- Install (4) no. 8 x 1/2" (12.7) sheet metal screws at the corners of the head to attach head to jambs
NOTE: REQUIRED FOR FIRE RATED FRAMES.

Manufacturer's Installation Instructions for Correct Location and Attachment of Anchors

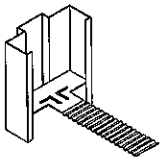

Masonry "T"

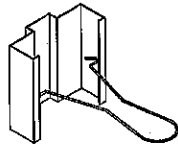

Masonry Wall

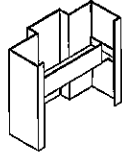

Steel Stud

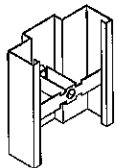

Existing Wall

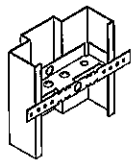

Multi-purpose

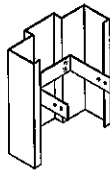

Wood Stud

A slip-in anchor must be used for each 30 inches of jamb height or fraction thereof. On the hinge jamb, each anchor must be located immediately above or below each hinge reinforcement. On the strike jamb, anchors must be located directly opposite the anchors on the hinge jamb.

Base anchors are not required on frames provided with expansion shell (existing wall) anchors. All other frame-anchor combinations must have a welded-in base anchor.

An additional jamb anchor must be added to frames using expansion shell anchors.

Anchor attachment methods may be slip-in force fit, spot welded, or arc welded to frame in proper locations.